

Pizza Prep Tables with Drawers

FPT Series

FPT-46-D2 FPT-67-D2 FPT-93-D2
 FPT-67-D4 FPT-93-D4
 FPT-93-D6



Item # _____

Standard Features

- Our pizza units are designed with durability and strength that you will not find in any other products in its class.
- All stainless steel interior and exterior construction for a clean & safe food environment. Coved corner floor to meet NSF requirements.
- Drawers: Heavy duty drawer slides with gentle self closing mechanism, full length recessed drawer handles; accommodate (2) 12" x 20" x 8" deep pans per drawer (pans sold separately).
- Doors: Heavy duty stainless steel doors with full length recessed door handles; interior instep design for added insulation and protection of door gaskets.
- Forced air design underneath the pans to keep products fresh and maintain temperature at 33° - 41°F in food pans and cabinet interior. Complies with NSF7 standards for food product safety.
- Insulated lid keeps pan temperature cold and minimizes condensation. Removable for easy cleaning.
- Side breathing refrigeration system for built-in applications.
- 19" full length removable and reversible white polyethylene cutting board.



FPT-46-D2



FPT-67-D4



FPT-93-D2

Options & Accessories

- 6" adjustable legs (set of 4)
- Additional epoxy coated shelves with channels
- Universal tray slides (pair)
- 220 volts / 50 cycles / 1 phase



*Conforms to UL & NSF-7 standards

Pizza Tables w/ Drawers	Model	Door	Drawers	Top Pans	HP	Volts	Amps	Capacity (cu. ft.)	Cord Length	Cabinet Dimensions			Shipping (Wt. / Cubes)	
										W	D**	H*		
	FPT-46-2D	0	2	6	1/4	115	5.4	9.9	8'	46"	36-1/4"	43-7/8"	368	63
	FPT-67-2D	1	2	9	1/3	115	6.5	18.6	8'	67-1/4"	36-1/4"	43-7/8"	486	73
	FPT-67-4D	0	4	9	1/3	115	6.5	18.6	8'	67-1/4"	36-1/4"	43-7/8"	526	73
	FPT-93-2D	2	2	12	1/3	115	6.5	26.5	8'	93-1/8"	36-1/4"	43-7/8"	596	92
	FPT-93-4D	1	4	12	1/3	115	6.5	26.5	8'	93-1/8"	36-1/4"	43-7/8"	636	92
	FPT-93-6D	0	6	12	1/3	115	6.5	26.5	8'	93-1/8"	36-1/4"	43-7/8"	676	92

* Depth does not include 1" bumper.

** Height does not include 5" casters (6" overall) or 6" optional legs.

Pizza Prep Tables with Drawers

FPT Series



Specification

Construction

Heavy duty stainless steel exterior top, front and sides. Galvanized back panel. Interior completely constructed of heavy duty stainless steel with coved corner floor. Door is heavy duty stainless steel exterior and interior, in-step design with hinged solid doors and positive seal. Drawer is heavy duty stainless steel with heavy duty drawer slides, self closing with a gentle close. Accommodates (2) 12" x 20" x 8" deep pan capacity (pans sold separately). Doors and Drawers provided with magnetic door gaskets, removable without tools, self-closing. Doors with 120° stay open feature / Drawers are full extension. Recessed full length handles.

Door / Drawer openings have a plastic breaker strips to retard condensate formation. Unit comes complete with a 2" CFC-Free polyurethane insulation, foamed in place.

Refrigeration System

Self-contained capillary tube system using environmentally friendly (CFC Free) R-134a refrigerant. Side mounted compressor on right side for built-in applications. Evaporator coil is mounted to interior top panel encased in stainless steel. Large fan motor and fan blades for better air flow.

Tables are designed to maintain temperatures between 33° F to 38° F in the interior cabinet and 41° F in the top rail.

Features

19" wide removable and reversible cutting board, NSF approved white polyethylene, ½ deep. Stainless steel insulated top lid keeps pan contents colder. Durable, long lasting and removable for easy cleaning.

Comes standard with standard 1/3 size, clear polycarbonate, NSF approved 4" deep food pans. Drawers come standard with (2) pan dividers.

Shelving

(2) Epoxy coated shelving per door with channel slides for supports. Adjustable in 2" increments per shelf.

Others

Unit is supplied standard with a 8' cord and plug (Nema 5-15p). Standard with 5" diameter casters, front two with brakes.

Warranty

2 year parts and labor warranty plus 2 additional year compressor warranty. (Continental U.S.A. & Canada only).

FPT-46-D2
Top View

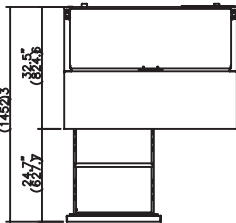

FPT-67-D4
Top View

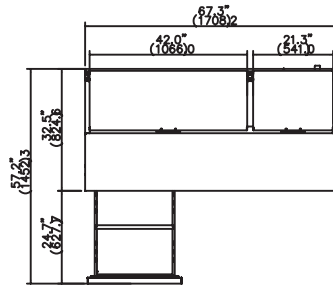

FPT-93-D6
Top View

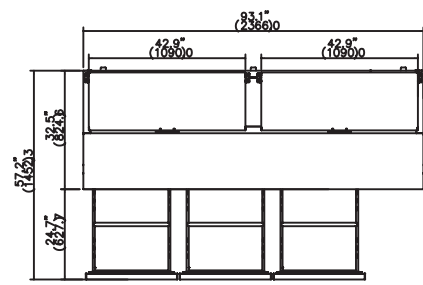

FPT-46-D2
Front View

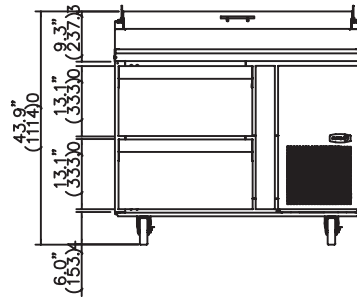

Common Side View

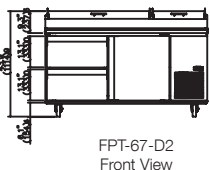
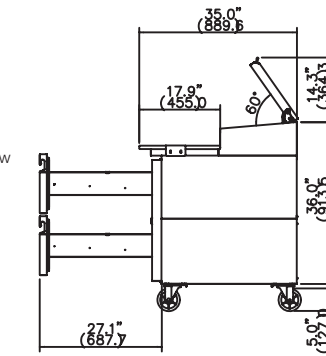

FPT-67-D2
Front View

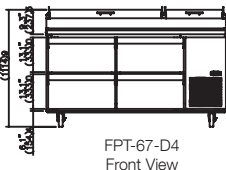

FPT-67-D4
Front View

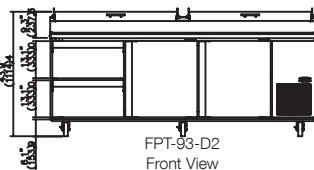

FPT-93-D2
Front View

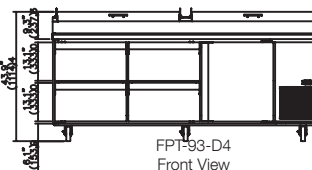

FPT-93-D4
Front View

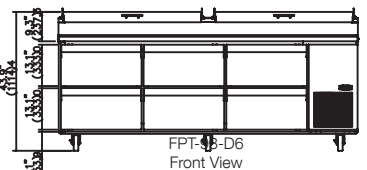

FPT-93-D6
Front View

The manufacturer reserves the rights to modify materials and specifications without notice.

The manufacturer reserves the rights to modify materials and specifications without notice.